

# ETR<sup>®</sup>

## MR16 Spotlight

### FEATURES

- Direct replacement for most halogen MR16 bulbs.
- Switching mode power designs give high-efficient and constant current source.
- Unique design for perfectly optical performance.
- Cool beam avoids heat degeneration.
- UV or IR free.
- Good thermal management guarantees a long service life.



**ETR Electronics Co.,Ltd.**

3, KE YUAN 1<sup>ST</sup> ROAD, CTSP, TAICHUNG, TAIWAN.

TEL:886-4-37032111 ; FAX:886-4-37031222

EMAIL:sales@etr.com.tw ; WEBSITE: www.etr.com.tw



## MR16 SPOTLIGHT

### 1. Applications:

Area: in door use only.

Purpose: spotlight. Accent lighting. Local lighting.

### 2. Specification :

Outline Dim. : (GX5.3)  $\phi$  50 x. 43mm (L)

(GU10)  $\phi$  50 x. 56mm (L)

(E27)  $\phi$  50 x. 68mm (L)

LED Light Source :3ea x1W (Nichia 083BT )

Color Temperature : 5200 $\pm$ 400 K / 3000 $\pm$ 300K

Input Voltage :12VAC (GX5.3) 90~240VAC (GU10.E27)

Power Consumption :4 W

Operation Temperature : -20 $^{\circ}$ C ~40 $^{\circ}$ C

Storage Temperature : -40 $^{\circ}$ C ~80 $^{\circ}$ C

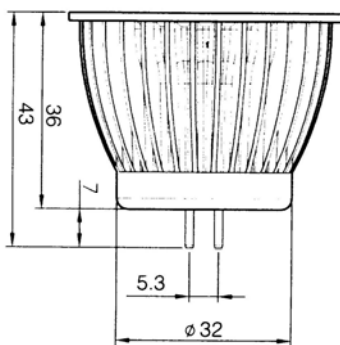

GX5.3

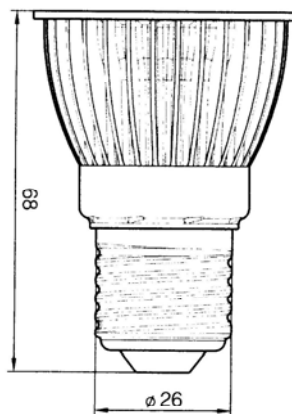

E27

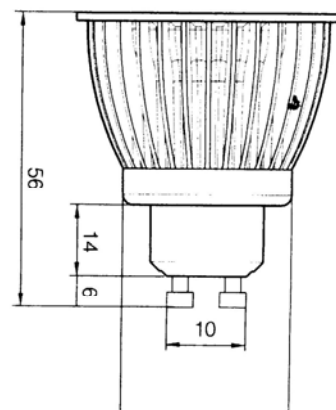

GU10

**ETR Electronics Co.,Ltd.**

3, KE YUAN 1<sup>ST</sup> ROAD, CTSP, TAICHUNG, TAIWAN.

TEL:886-4-37032111 ; FAX:886-4-37031222

EMAIL:sales@etr.com.tw ; WEBSITE: www.etr.com.tw



## **MR16 SPOTLIGHT**

### **3. Packaging information :**

Packing : 100 boxes / carton		
Box	65x65x85mm	90g
Carton	352x352x368mm	9.9 kg

#### **GX5.3**

Packing : 100 boxes / carton		
Box	65x65x85mm	100g
Carton	352x352x368mm	10.9 kg

#### **GU10**

Packing : 100 boxes / carton		
Box	65x65x85mm	100g
Carton	352x352x368mm	10.9 kg

#### **E27**

**ETR Electronics Co.,Ltd.**

3, KE YUAN 1<sup>ST</sup> ROAD, CTSP, TAICHUNG, TAIWAN.

TEL:886-4-37032111 ; FAX:886-4-37031222

EMAIL:sales@etr.com.tw ; WEBSITE: www.etr.com.tw



## MR16 SPOTLIGHT

### 4. Product Series :

#### GX5.3 (3X1W LED)

Color Temp.	Model No.	Beam Angle (2 $\theta_{1/2}$ )	Output Lumens	CRI
5200 $\pm$ 400K	MX5A1H	60 degree	169	70
3000 $\pm$ 300K	MX3A10	60 degree	117	75

Note: Data are measured after lighting up 60min.

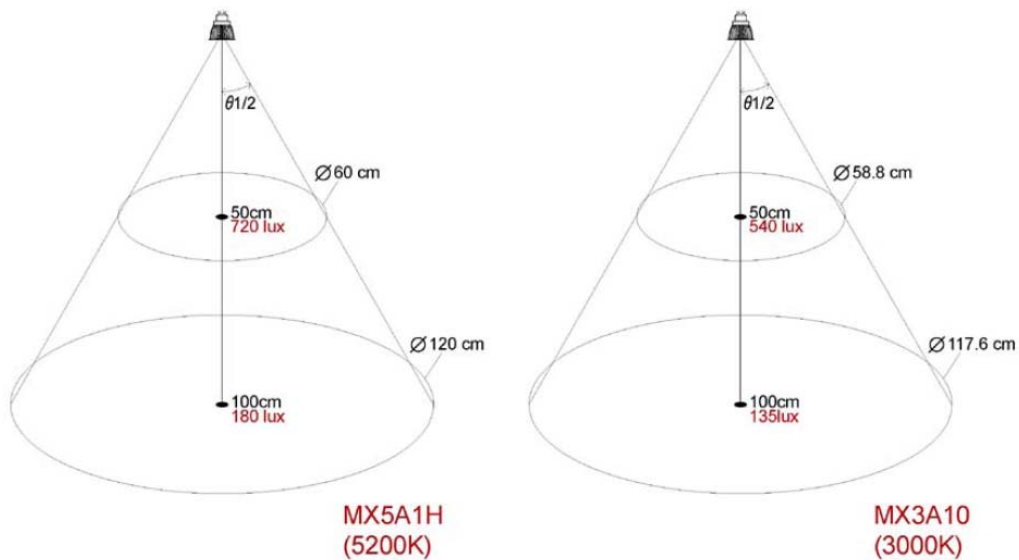

$\theta_{1/2}$  is the off axis angle from luminaries centerline where the intensity is half of the peak value.

#### **ETR Electronics Co.,Ltd.**

3, KE YUAN 1<sup>ST</sup> ROAD, CTSP, TAICHUNG, TAIWAN.

TEL:886-4-37032111 ; FAX:886-4-37031222

EMAIL:sales@etr.com.tw ; WEBSITE: www.etr.com.tw



## MR16 SPOTLIGHT

### GU10 (3X1W LED)

Color Temp.	Model No.	Beam Angle (2 $\theta_{1/2}$ )	Output Lumens	CRI
5200 $\pm$ 400K	MU5A1H	60 degree	169	70
3000 $\pm$ 300K	MU3A10	60 degree	117	75

Note: Data are measured after lighting up 60min.

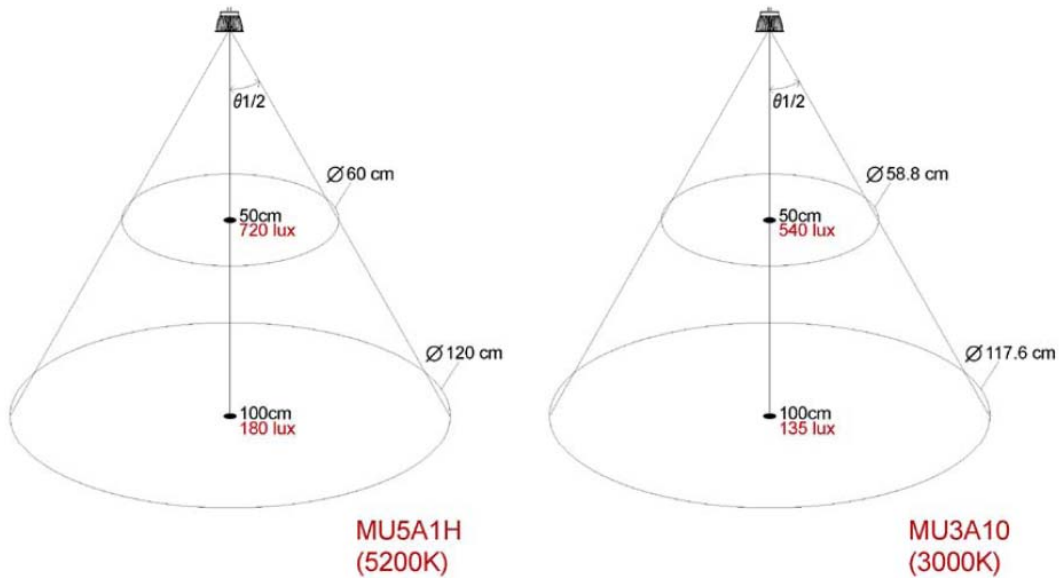

$\theta_{1/2}$  is the off axis angle from luminaries centerline where the intensity is half of the peak value.

### ETR Electronics Co.,Ltd.

3, KE YUAN 1<sup>ST</sup> ROAD, CTSP, TAICHUNG, TAIWAN.

TEL:886-4-37032111 ; FAX:886-4-37031222

EMAIL:sales@etr.com.tw ; WEBSITE: www.etr.com.tw



## MR16 SPOTLIGHT

E27 (3X1W LED)

Color Temp.	Model No.	Beam Angle (2 $\theta_{1/2}$ )	Output Lumens	CRI
5200 $\pm$ 400K	ME5A1H	60 degree	169	70
3000 $\pm$ 300K	ME3A10	60 degree	117	75

Note: Data are measured after lighting up 60min.

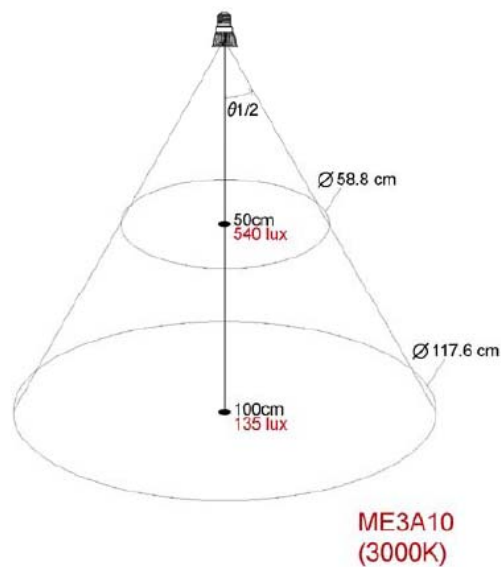
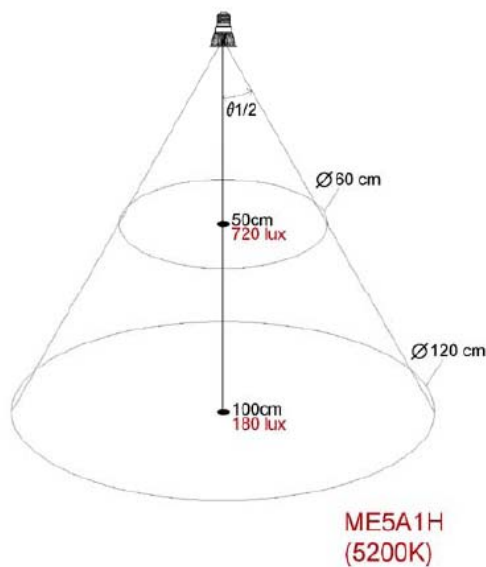

$\theta_{1/2}$  is the off axis angle from luminaries centerline where the intensity is half of the peak value.

## MR16 SPOTLIGHT

**ETR Electronics Co.,Ltd.**

3, KE YUAN 1<sup>ST</sup> ROAD, CTSP, TAICHUNG, TAIWAN.

TEL:886-4-37032111 ; FAX:886-4-37031222

EMAIL:sales@etr.com.tw ; WEBSITE: www.etr.com.tw



## **5. Operation manual :**

-This product recommended to use on -20~40°C environment which can guarantee the long life.

## **6. Safety warning :**

-Don't drop the product since it will damage the pins or screw head.  
The product is not waterproof.  
-Don't have a sharp material to impact the top surface of product  
Since it will spark the light pattern.

-

## **7. Installation guide :**

-Directly plug into the base.

## **8. Average life time :**

-Lighting luminary :10 years  
-LED : 50000 hours  
-System : 20000 hours

## **9. Warranty :**

-1 year.

### **ETR Electronics Co.,Ltd.**

3, KE YUAN 1<sup>ST</sup> ROAD, CTSP, TAICHUNG, TAIWAN.

TEL:886-4-37032111 ; FAX:886-4-37031222

EMAIL:sales@etr.com.tw ; WEBSITE: www.etr.com.tw